

DV603 Double Glass

Finiture cromatiche/Colour finishes

Vetro/Glass

Sp. 0.5 + 0.5 cm - 0.6 + 0.6 cm / 0.5 + 0.5 - 0.6 + 0.6 cm thick



Stratificato
Extra-chiaro/Extra
clear stratified

Stratificato
trasparente
/Transparent stratified

Telaio/Frame

Profilo 6.4 x 4.5 cm / 6.4 x 4.5 cm profile



Anodizzato
/Anodized

Brill/Brill

Verniciato RAL ...
/RAL Painted ...

Pannelli ☒ / Panels ☒



Bianco/White

Grigio chiaro
/Light grey

Noce/Walnut

Rovere chiaro
/Light oak

Rovere Moro
/Dark oak

Rovere tabacco
/Tobacco oak

DV603 Double Glass

Dati tecnici/Technical data

Pareti doppioglasso/Double-glass partitions

P 6,4

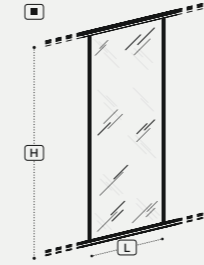

Moduli vetro/Glass partitions

Profili per moduli vetro ad angolo/Glass module corner profiles

Profili/Profiles

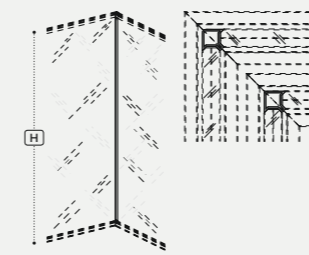

Per modulo angolo 90° a 2 vie
/For 2 way 90° corner module

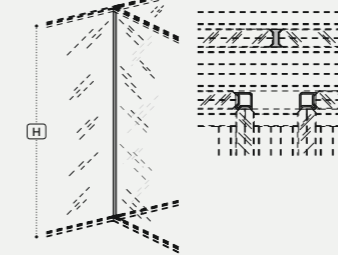

Per modulo angolo 90° a 3 vie
/For 3 way 90° corner module

L 4,5 P 6,4

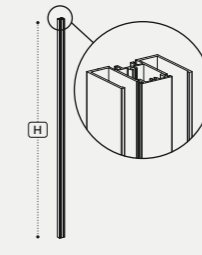

Profilo di partenza fisso
/Fixed start profile

L 1,6 P 6,4

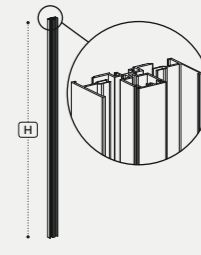

Profilo di chiusura con
elemento mobile/End profile
with movable element

L 1,6 P 6,4

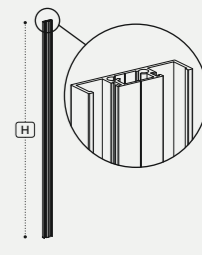

Profilo terminale
/Terminal profile

Porte/Doors

L 95 P 6,4

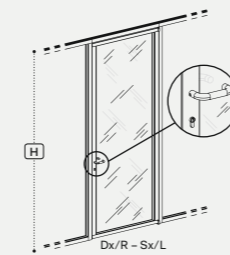

Porta anta battente vetro
/Single hinged glass door

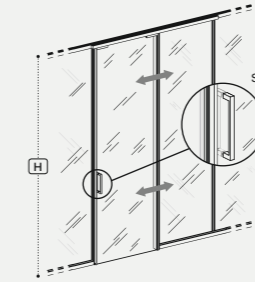

Porta anta scorrevole vetro
/Sliding glass door

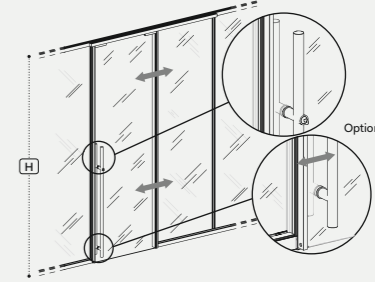

Porta anta scorrevole vetro con maniglione
/Glass sliding door with bar handle

L 190 P 6,4

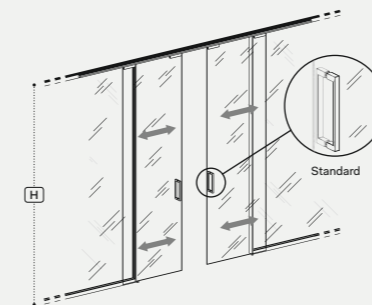

Porta scorrevole doppia anta in vetro
/Double sliding glass door

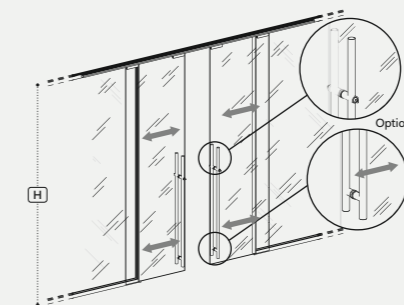

Porta scorrevole doppia anta in vetro
/Double glass sliding door

Note:

☒ A richiesta altre finiture. Per quantitativi minimi contattare l'ufficio commerciale / On request other finishes. For minimum quantities contact the sales office;

▣ Articoli prodotti solo su richiesta / Articles produced only on request.

Note:

1 Le dimensioni sono espresse in cm - consultare il listino prezzi per le caratteristiche tecniche, i codici degli articoli e delle finiture / Dimensions are stated in cm - for technical characteristics, article code numbers and finishing see price list;

2 La quotazione delle pareti monoglasso verrà effettuata in base ai m² richiesti (HxL) / The quotation of the mono-glass partitions will be calculated according the required square meters (HxL).